

FEATURES:

BURGLAR BAR INSERTS ARE FABRICATED OF 18 GA G90
GALVANIZED STEEL AND 1/2" STEEL ROD

ONE-PIECE WELDED CONSTRUCTION

FACTORY PAINTED

DISTANCE BETWEEN STEEL RODS IS NOT GREATER THAN 6"

OPTIONS:

5/8" STEEL ROD

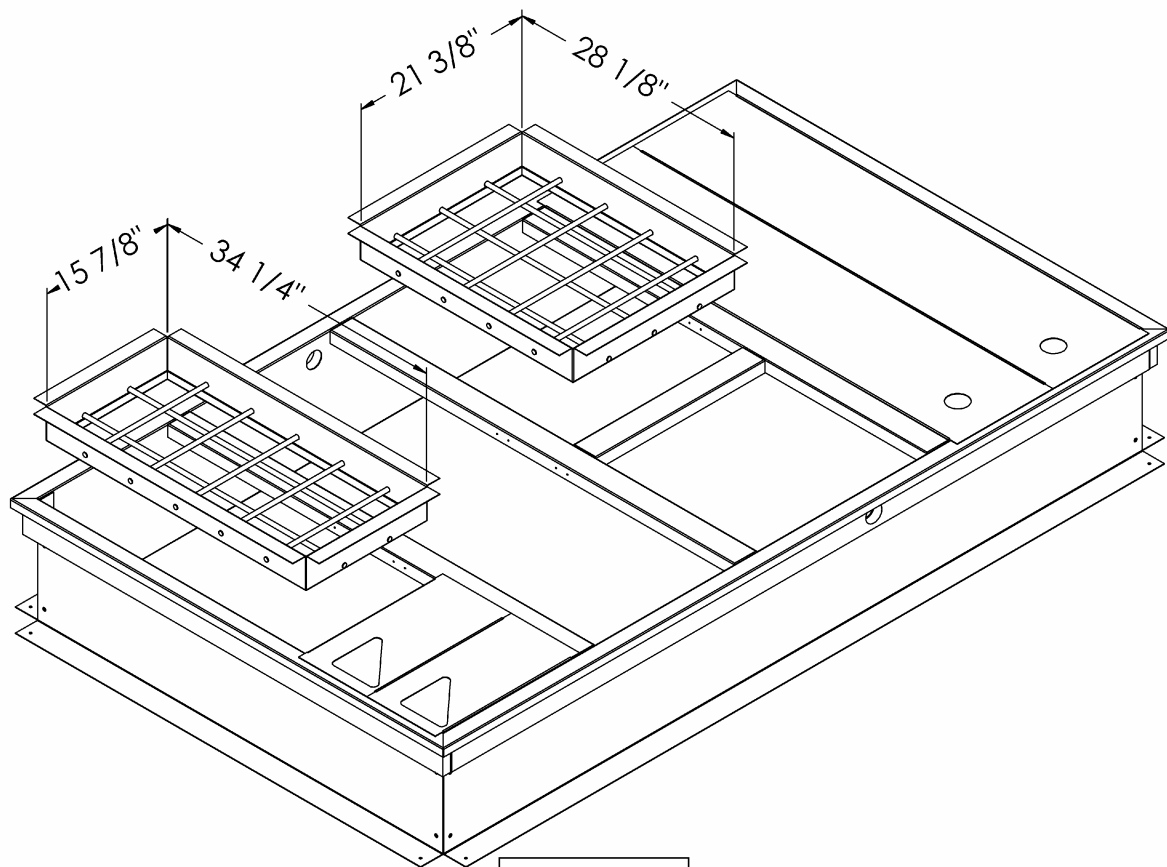

CAS PART #
1005907