

DATE: _____
 COMPANY: _____
 JOB NAME: _____
 SUBMITTED BY: _____
 NOTES: _____

FLUSH MOUNT HARD DUCT
 SUBMITTAL DATA FOR:
CARRIER UNITS
48/50PG14

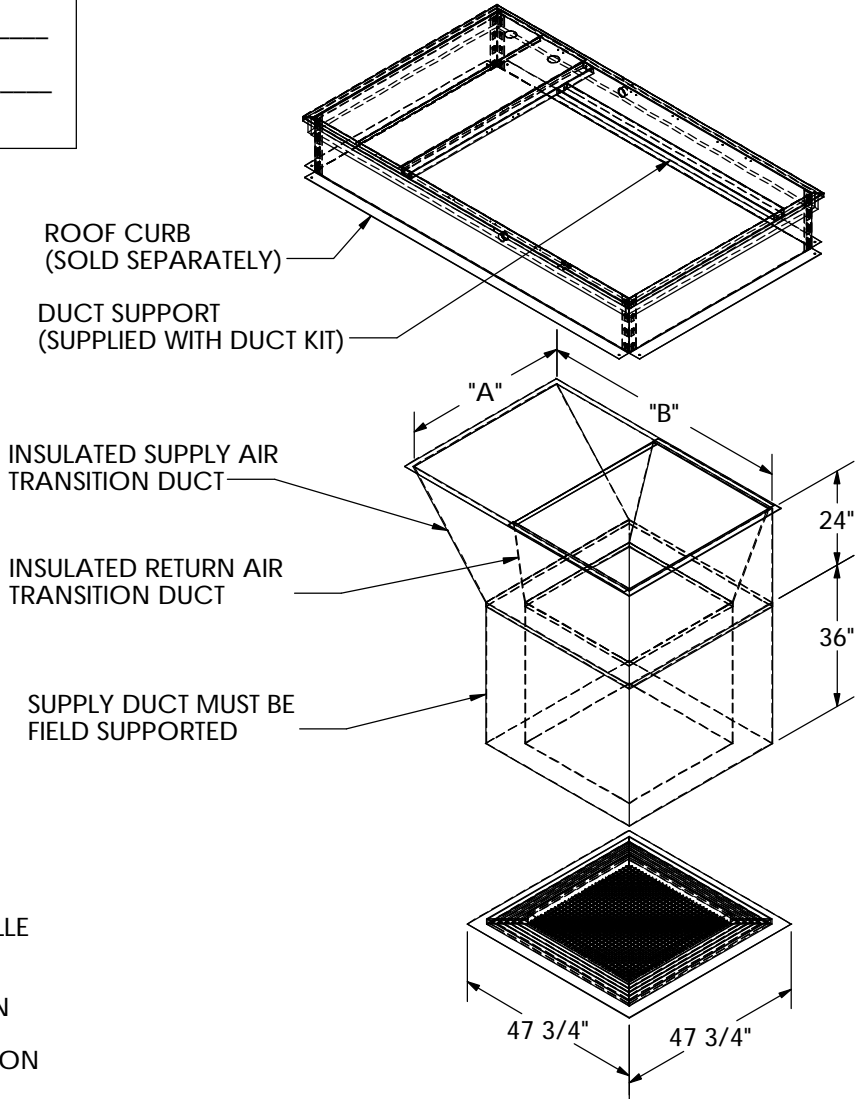

FEATURES:

- FLUSH MOUNT PAINTED WHITE DIFFUSER GRILLE WITH FIXED BLADES
- SUPPLY DUCT INSULATED WITH 1" INSULATION
- RETURN DUCT INSULATED WITH 1/2" INSULATION

CAMBRIDGEPORT PART NUMBER	APPLICABLE CURB MODEL NUMBERS	"A"	"B"	DIFFUSER SIZE	RETURN GRILL	NOMINAL CFM	THROW IN FT.	
							MIN	MAX
1010342	CPRFCURB0031A00SL	42 1/4"	63 5/8"	42" X 42"	30" X 30"	5,000	23'	41'

NOTES:

- 1 - DO NOT INSTALL FACTORY SUPPLIED DUCT SUPPORTS UNLESS NOTED IN ASSEMBLY INSTRUCTIONS
- 2 - INSTALL CONCENTRIC DUCTWORK BEFORE SETTING A/C UNIT IN PLACE
- 3 - PLACE GASKETING ON ALL SURFACES OF DUCT FLANGE AND CURB
- 4 - ALIGN CARRIER UNIT SUPPLY OPENING TO MATCH SUPPLY OPENING OF CONCENTRIC DUCT KIT
- 5 - FIELD BAFFLES MAY BE REQUIRED FOR BALANCING
- 6 - FOR INSTALLATION SEE ASSEMBLY INSTRUCTIONS

Drawn By: CRF
 Date: 2/13/08 Rev: 0

Cambridgeport
AIR SYSTEMS

MEMPHIS, TN 38118
 PHONE 1-877-648-2872 FAX 901-566-0035
 SALISBURY, MA 01952
 PHONE 1-800-648-2872 FAX 978-462-9189