

Cambridgeport

SUBMITTAL

SUBMITTED TO _____
 COMPANY _____
 JOB NAME _____
 EQUIPMENT _____
 SIGNATURE _____
 DATE _____

ROOF CURBS FOR TRANE ROOFTOP UNITS

2/4 TC*/ WC*/ YC*3 042-060A

PART #		PART #	CURB HEIGHT
CAS	TRANE	INSULATED	"A"
1009685	BAYCURB051	1011831	14"
1011826	N/A	1011830	8"
1011828	N/A	1011832	18"
1011829	N/A	1011833	24"

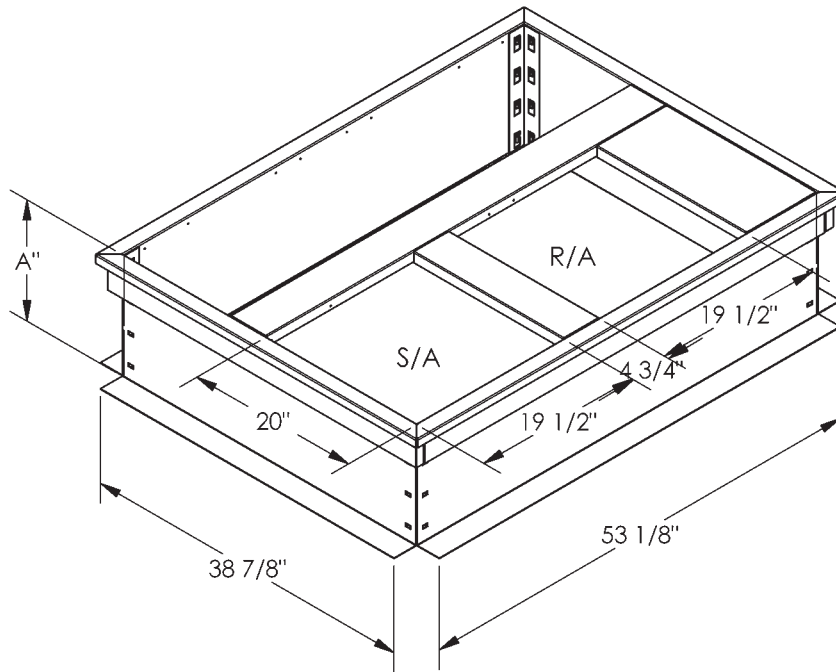

FEATURES

- MITERED TOP CORNERS
- ROOF CURB IS FABRICATED OF 18GA G90 GALVANIZED STEEL
- FULL PERIMETER WOOD NAILER
- PRE-PUNCHED ASSEMBLY HOLES AND HARDWARE INCLUDED FOR - DUCT SUPPORT INSTALLATION
- ROOF CURB IS SHIPPED UNASSEMBLED
- * CURBS ARE INTERNALLY INSULATED WITH 1" THICK 1-1/2 LB DENSITY DUCT LINER

