

# Cambridgeport

## SUBMITTAL

Part Number  
2003617

SUBMITTED TO \_\_\_\_\_  
COMPANY \_\_\_\_\_  
JOB NAME \_\_\_\_\_  
EQUIPMENT \_\_\_\_\_  
SIGNATURE \_\_\_\_\_  
DATE \_\_\_\_\_

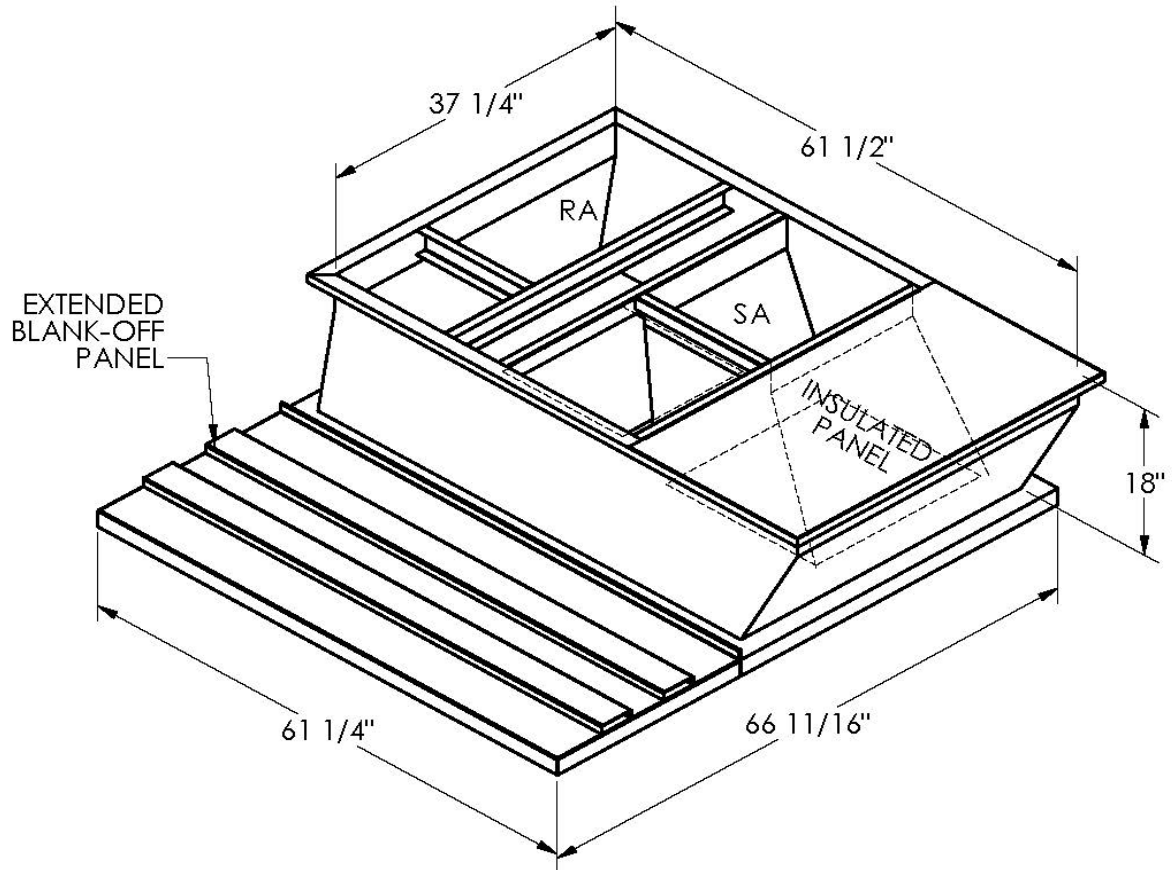

## FEATURES

- ONE PIECE WELDED CONSTRUCTION
- FACTORY INSTALLED SUPPLY TRANSITIONS
- FULLY INSULATED
- DESIGNED FOR EVEN WEIGHT DISTRIBUTION
- FABRICATED OF HEAVY GAUGE G90 GALVANIZED STEEL
- ALL WELDS SPRAYED WITH GALVANIZING COMPOUND
- GASKET PROVIDED FOR UNIT TO ADAPTER SEALING

**CAMBRIDGEPORT STRONGLY RECOMMENDS CONFIRMING THE DIMENSIONS ON THIS SUBMITTAL**

CURB ADAPTERS ARE BASED ON UNIT MANUFACTURERS STANDARD CURB DIMENSIONS.  
CAMBRIDGEPORT CANNOT BE RESPONSIBLE FOR ANY DEVIATIONS FROM FACTORY DIMENSIONS OR INCORRECT MODEL NUMBERS.