

Cambridgeport

SUBMITTAL

Part Number
2004091

SUBMITTED TO _____
COMPANY _____
JOB NAME _____
EQUIPMENT _____
SIGNATURE _____
DATE _____

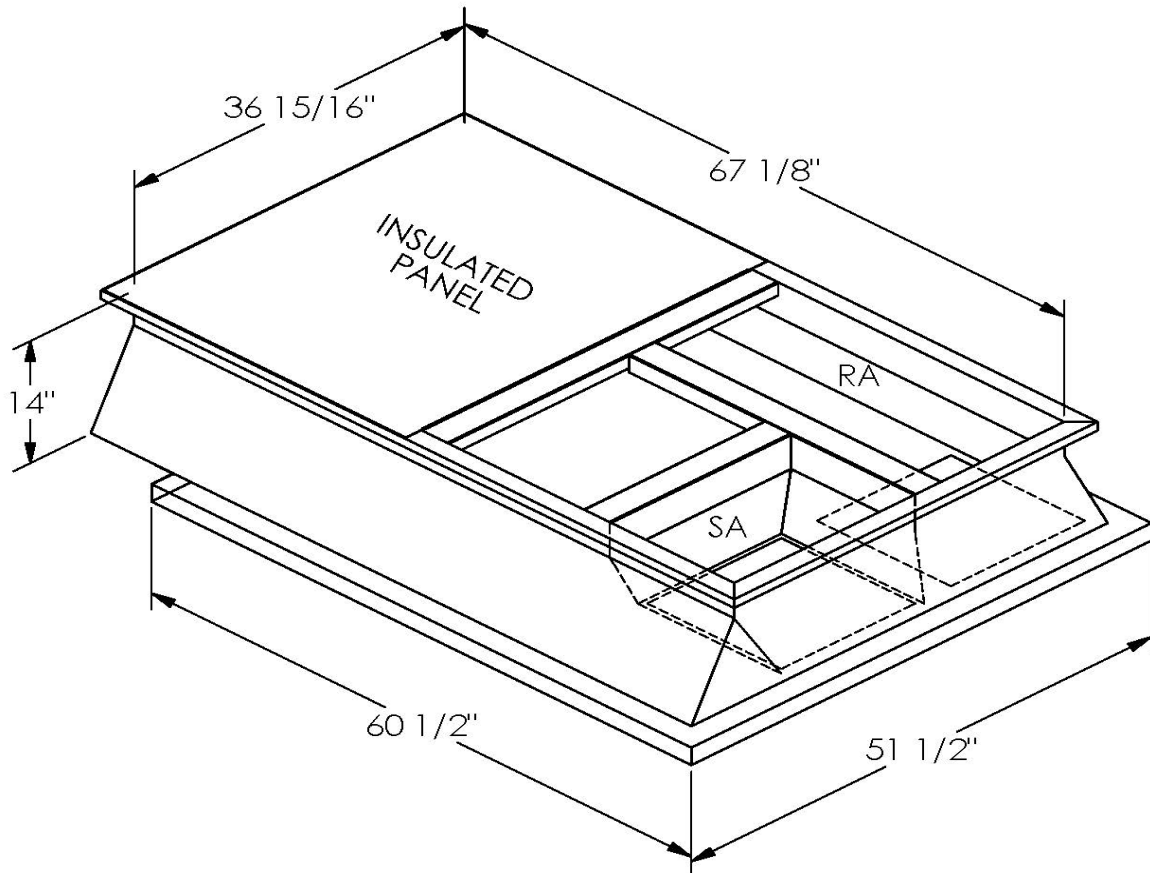

FEATURES

- ONE PIECE WELDED CONSTRUCTION
- FACTORY INSTALLED SUPPLY TRANSITIONS
- FULLY INSULATED
- DESIGNED FOR EVEN WEIGHT DISTRIBUTION
- FABRICATED OF HEAVY GAUGE G90 GALVANIZED STEEL
- ALL WELDS SPRAYED WITH GALVANIZING COMPOUND
- GASKET PROVIDED FOR UNIT TO ADAPTER SEALING

CAMBRIDGEPORT STRONGLY RECOMMENDS CONFIRMING THE DIMENSIONS ON THIS SUBMITTAL

CURB ADAPTERS ARE BASED ON UNIT MANUFACTURERS STANDARD CURB DIMENSIONS.
CAMBRIDGEPORT CANNOT BE RESPONSIBLE FOR ANY DEVIATIONS FROM FACTORY DIMENSIONS OR INCORRECT MODEL NUMBERS.